

# SNOW DAY

-US

Operator Manual

V1.2



# Contents

1. Machine instructions.....	2
2. Machine setting & Test instructions.....	11
3. Fault & Resolution.....	18
4. Machine maintenance.....	21
5. Wiring schematic.....	23

# 1. Machine instructions

## 1. 1. Specification and Parameter

- 1.Voltage: AC110V 50/60Hz
- 2.Dimension: W1100×D1620×H2985mm (Assembly)
- 3.Weight: About 210 Kg
- 4.Power: 795W

## 1. 2. Considerations

- 1.Suitable for indoor environment
- 2.Please do not placed in the tilted position, so as to avoid accidents
- 3.Please do not use it in the following places:
  - ❖ In the dusty environment;
  - ❖ In the high temperature or airiness environment ;
  - ❖ A condensing place that causes a machine to produce condensed water or humidity.;
  - ❖ Near hot objects ;
  - ❖ Dangerous object ;
  - ❖ Strong magnetic interference ;
  - ❖ Near devices that are prone to spark;;
  - ❖ Voltage instability or voltage is too low ;
  - ❖ Vibration serious place ;
- 4.The machine must be assembled and fixed in accordance with assembly instructions before normal operation.
- 5.Before moving, must turn off the power and unplug the power cord
- 6.If the caster can not move when moving, the machine's foot seat is put away, please confirm whether the bottom surface is flat.
- 7.Random human movement, flip, transport, etc. can damage equipment, damage machine performance.
- 8.Confirm in the process of moving, overturning, transporting and so on to meet the requirements of the manufacturers.

### 1.3. Installation notes

#### 1.3.1. Packaging List

NO.	Description	Code	Unit	Qty
1	Main cabinet		SET	1
2	Coin cabinet		SET	1
3	Ticket cabinet		SET	1
4	Step assembly		SET	1
5	Power cabinet		SET	1
6	The top signboard		PCS	1
7	Balls		PCS	500
8	Cross head screw	M4x8	PCS	6
9	Cross head screw	M5x12	PCS	11
10	Socket hexagon head screw	M5x10	PCS	4
11	Key 1		PCS	2
12	Key 2		PCS	2
13	Operator Manual		PCS	1
14	AC Power cord		PCS	1

#### 1.3.2. Unpack the packing material of each part of the machine

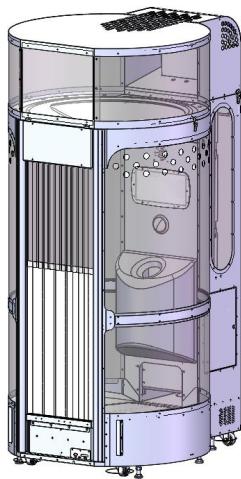

Main cabinet

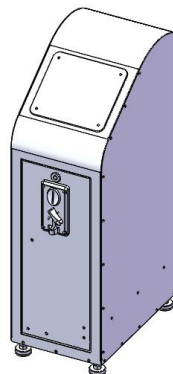

Coin cabinet

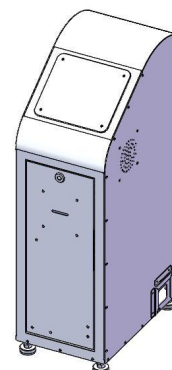

Ticket cabinet

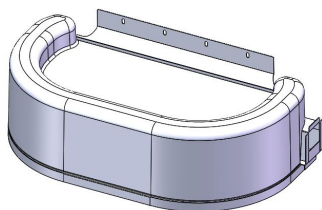

Step assembly

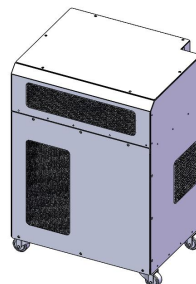

Power cabinet



Accessories Box



The top signboard



Balls



1. 3. 3. Install the power cabinet to the Main cabinet as below.

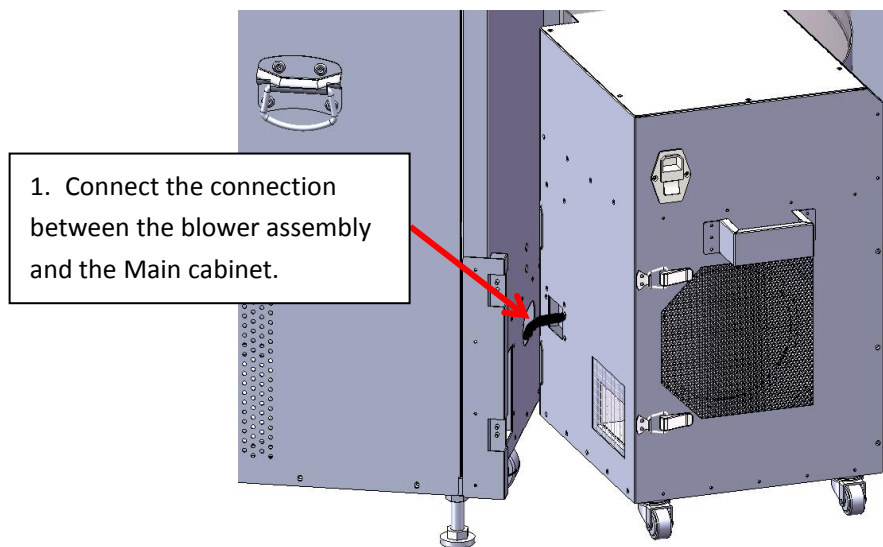

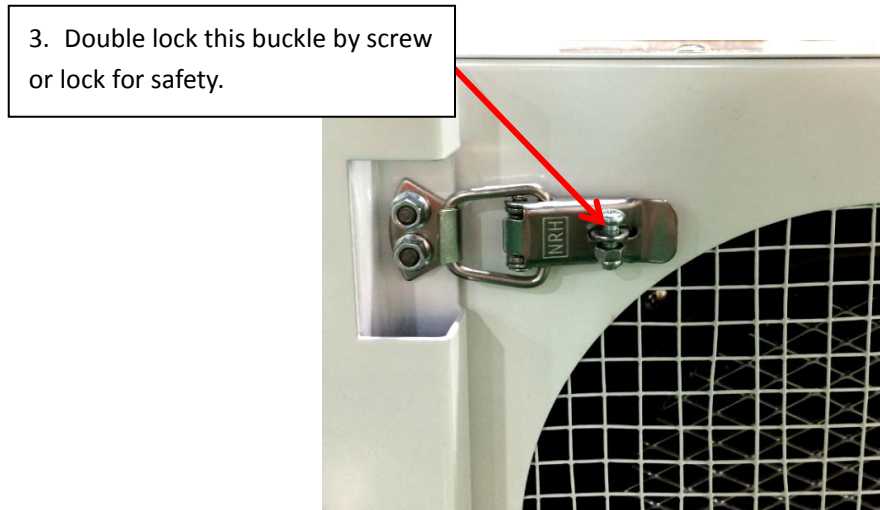
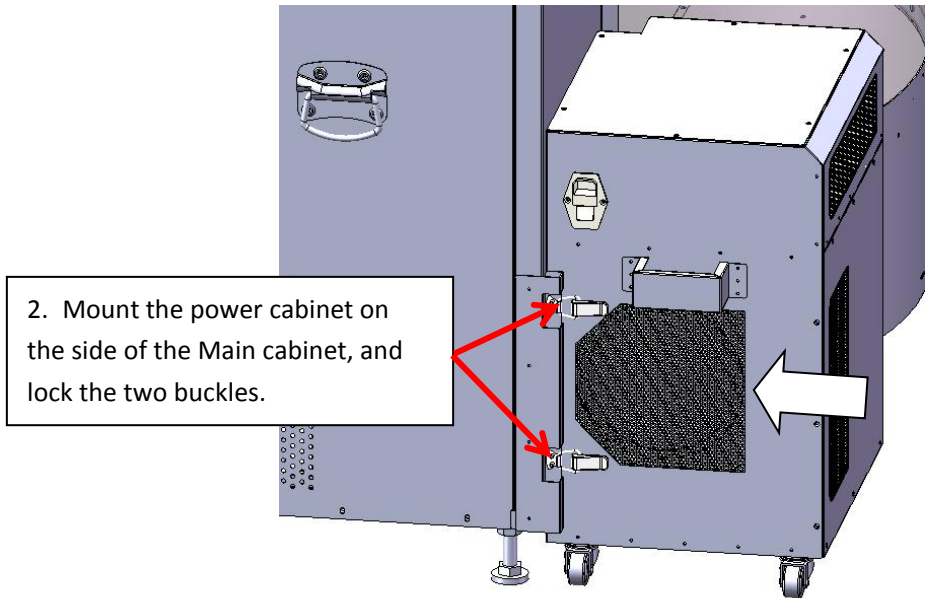

1. 3. 4. Move the Main cabinet to a suitable position, then unscrew the 6 feet of the machine, adjust the height of the foot, ensure that all casters are off the ground and the force of each foot is close.



1. 3. 5. Install the Step assembly, Ticket cabinet and Coin cabinet to the Main cabinet by bolts.

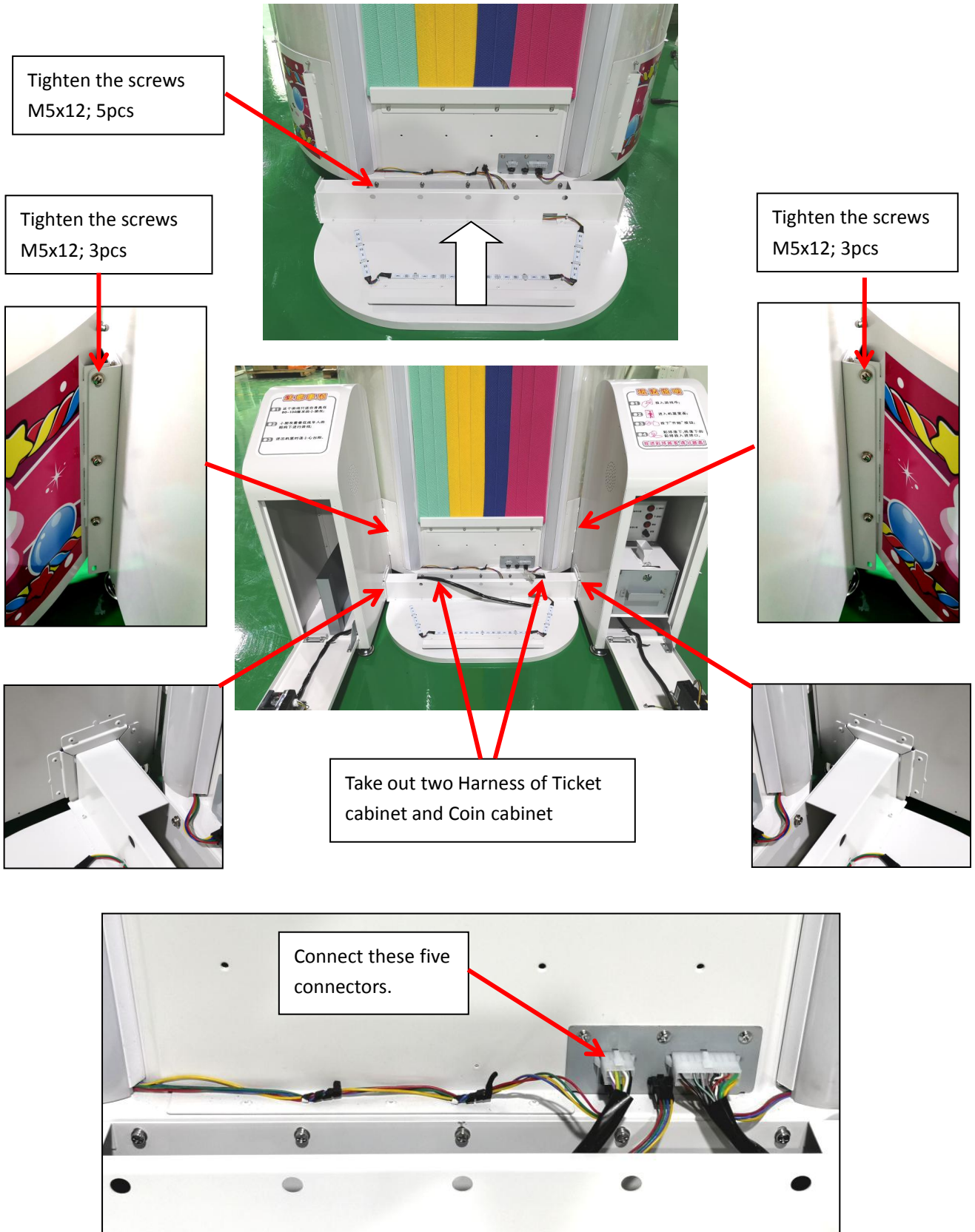



1. 3. 6. Install the top signboard with main cabinet by bolts.





### 1. 4. How to play

Game construction:

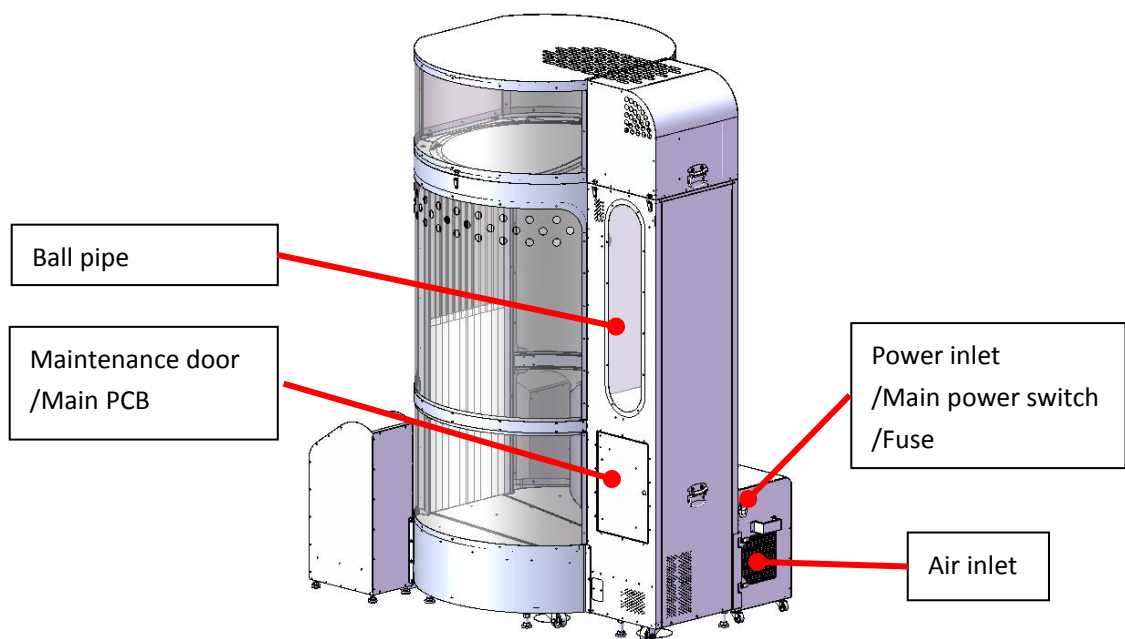
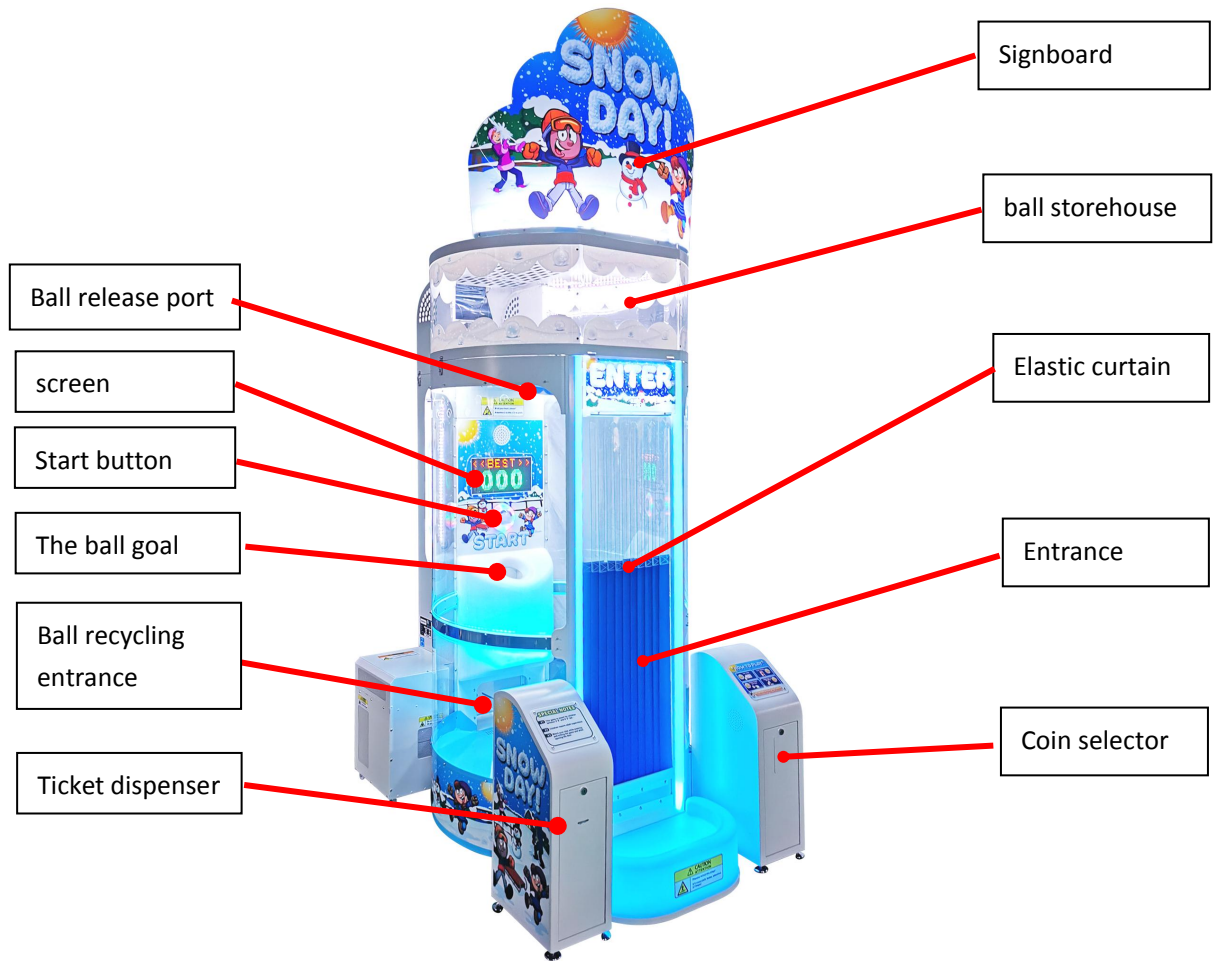

## How to play the game:

1. Insert the coins, the machine will be ready soon.
2. Open the curtain and enter game house carefully.
3. When display screen show “DOWN ARROW”, Press “START BUTTON” to start the game.
4. The ball release port open automatically, and balls are falling down for game play. At the same time, ball collector in the bottom also start to work.
5. Player insert the balls into goal to get points, the relevant points will display on the screen.
6. Game over when time runs out, then the goal will not be scoring.
7. Player will get the tickets according to their points (optional).
8. The balls on the play area will be collected by the game automatically, then back to standby mode.

## 1. 5. Balls Request

1. Please use the original factory color ball. If other colored balls are used, the diameter of the ball should be between 70mm and 80mm. The weight of the ball is between 4 to 7.5g.
2. The number of balls placed inside the machine game needs to match the game time and the ball time.
3. It is assumed that the recommended amount of Reclaim time and the number of balls is as follows:

### Reclaim time = Game time - Drop time

ball	100pcs	200pcs	300pcs	400pcs	500pcs
Reclaim time	10s	20s	30s	40s	50s

\*This recommended data is the player in the ordinary pitching speed measurement, please follow the actual situation increase and decrease the number of balls.

## 1. 6. Game considerations

1. This game is only suitable for children standing at 80-130cm.
2. Children need to be accompanied by adults to play games.
3. Don't let the child get into the back of the recycling ball. Don't put your hand into the goal.
4. It can not enter 3 or more people at the same time, in case of accident.
5. Children feel uncomfortable and need to stop the game.
6. Operator should clean the game daily to bring the player a comfortable game area.
7. This game should be operated by 300 pieces of balls.

## 1. 7. Machine Movement considerations

1. Be sure to pick up each foot before the movement.
2. Remove the fan assembly if you move it on uneven ground.
3. The individual components must be packed and transported for long distances.
4. Long distance transport needs to set an EPE and other shockproof materials in the bottom door.(as below)

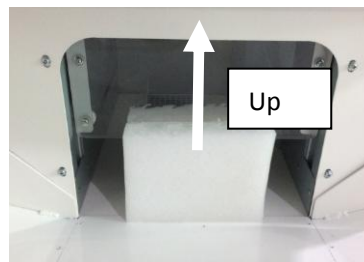

5. If encounter the gate is not high enough when the machine moving, you can remove the top assembly and then move. (as below)

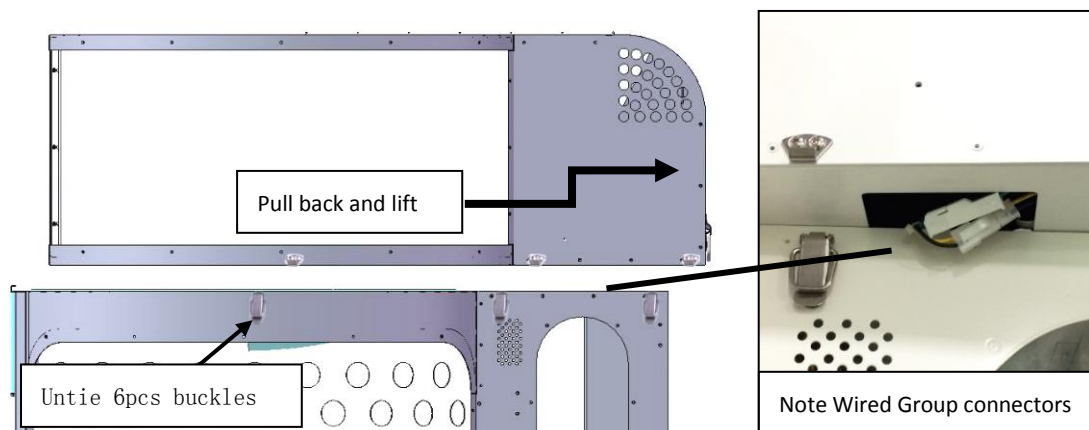

## 2. Machine setting & Test instructions

### 2. 1. DIP switch setting

The DIP switches on the machine board :

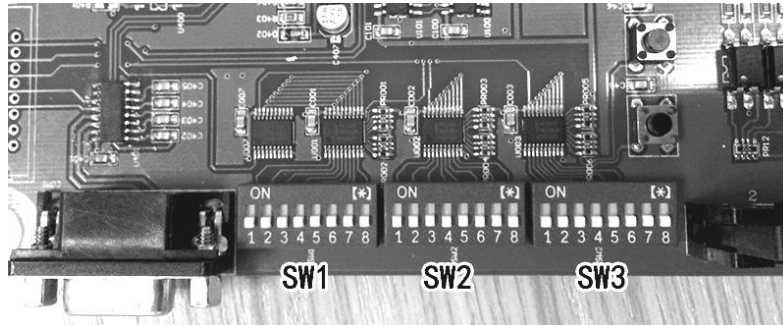

#### SW1 :

Item	Coins			Drop time (The time of the ball felling.)		Game time (Total game time)		
	1	2	3	4	5	6	7	8
Free	OFF	OFF	OFF					
1 Coin/Game	ON	OFF	OFF					
2 Coins/Game	OFF	ON	OFF					
3 Coins/Game	ON	ON	OFF					
4 Coins/Game	OFF	OFF	ON					
5 Coins/Game	ON	OFF	ON					
6 Coins/Game	OFF	ON	ON					
7 Coins/Game	ON	ON	ON					
0s				OFF	OFF			
10s				ON	OFF			
20s				OFF	ON			
45s				ON	ON			
30s Game								
45s Game						ON	OFF	OFF
60s Game						OFF	ON	OFF
70s Game						ON	ON	OFF
80s Game						OFF	OFF	ON
90s Game						ON	OFF	ON
100s Game						OFF	ON	ON
120s Game						ON	ON	ON
Defaults	ON	OFF	OFF	OFF	ON	OFF	ON	OFF

**SW2 :**

Item	Score				Item	Fixed Ticket			
	1	2	3	4		5	6	7	8
1 Score/ball	OFF	OFF	OFF	OFF	No Ticket (Regular ticket)	OFF	OFF	OFF	OFF
2 Score/ball	<b>ON</b>	OFF	OFF	OFF	1 Ticket/Game	<b>ON</b>	OFF	OFF	OFF
3 Score/ball	OFF	<b>ON</b>	OFF	OFF	2 Tickets/Game	OFF	<b>ON</b>	OFF	OFF
4 Score/ball	<b>ON</b>	<b>ON</b>	OFF	OFF	3 Tickets/Game	<b>ON</b>	<b>ON</b>	OFF	OFF
5 Score/ball	OFF	OFF	<b>ON</b>	OFF	4 Tickets/Game	OFF	OFF	<b>ON</b>	OFF
6 Score/ball	<b>ON</b>	OFF	<b>ON</b>	OFF	5 Tickets/Game	<b>ON</b>	OFF	<b>ON</b>	OFF
7 Score/ball	OFF	<b>ON</b>	<b>ON</b>	OFF	6 Tickets/Game	OFF	<b>ON</b>	<b>ON</b>	OFF
8 Score/ball	<b>ON</b>	<b>ON</b>	<b>ON</b>	OFF	7 Tickets/Game	<b>ON</b>	<b>ON</b>	<b>ON</b>	OFF
9 Score/ball	OFF	OFF	OFF	<b>ON</b>	8 Tickets/Game	OFF	OFF	OFF	<b>ON</b>
10 Score/ball	<b>ON</b>	OFF	OFF	<b>ON</b>	9 Tickets/Game	<b>ON</b>	OFF	OFF	<b>ON</b>
15 Score/ball	OFF	<b>ON</b>	OFF	<b>ON</b>	10 Tickets/Game	OFF	<b>ON</b>	OFF	<b>ON</b>
20 Score/ball	<b>ON</b>	<b>ON</b>	OFF	<b>ON</b>	12 Tickets/Game	<b>ON</b>	<b>ON</b>	OFF	<b>ON</b>
25 Score/ball	OFF	OFF	<b>ON</b>	<b>ON</b>	15 Tickets/Game	OFF	OFF	<b>ON</b>	<b>ON</b>
30 Score/ball	<b>ON</b>	OFF	<b>ON</b>	<b>ON</b>	18 Tickets/Game	<b>ON</b>	OFF	<b>ON</b>	<b>ON</b>
35 Score/ball	OFF	<b>ON</b>	<b>ON</b>	<b>ON</b>	20 Tickets/Game	OFF	<b>ON</b>	<b>ON</b>	<b>ON</b>
40 Score/ball	<b>ON</b>	<b>ON</b>	<b>ON</b>	<b>ON</b>	25 Tickets/Game	<b>ON</b>	<b>ON</b>	<b>ON</b>	<b>ON</b>
Defaults	OFF	OFF	OFF	OFF	Defaults	OFF	OFF	OFF	OFF

**SW3 :**

Item	Regular ticket			Save	Standby	Clean ball	7	8
	1	2	3					
No Ticket	OFF	OFF	OFF					
1 Score/Ticket	<b>ON</b>	OFF	OFF					
2 Score/Ticket	OFF	<b>ON</b>	OFF					
3 Score/Ticket	<b>ON</b>	<b>ON</b>	OFF					
5 Score/Ticket	OFF	OFF	<b>ON</b>					
10 Score/Ticket	<b>ON</b>	OFF	<b>ON</b>					
20 Score/Ticket	OFF	<b>ON</b>	<b>ON</b>					
30 Score/Ticket	<b>ON</b>	<b>ON</b>	<b>ON</b>					
Not save coin and ticket				OFF				
Save coin and ticket				<b>ON</b>				
No demo					OFF			
With demo					<b>ON</b>			
Don't Collect the balls after a game						OFF		
Collect the balls after a game						<b>ON</b>		
Defaults	OFF	OFF	OFF	OFF	<b>ON</b>	<b>ON</b>	OFF	OFF

## 2.2. Test instructions

### Setting Panel Description

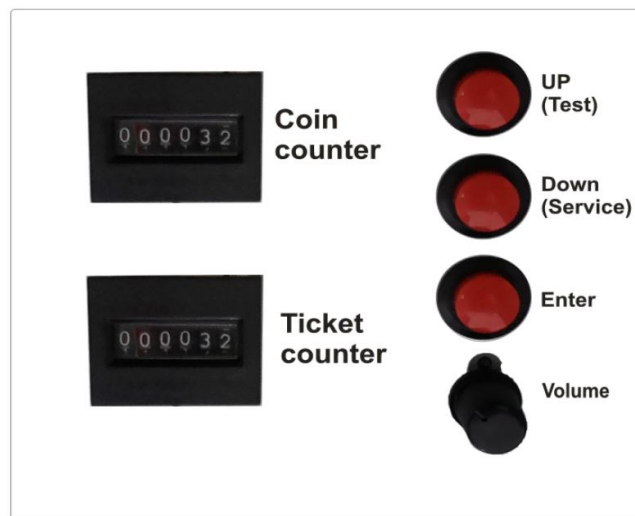

**Up(test):** Click to enter the test mode when standby, Turn up in the test mode.

**Down(service):** Click to free game once when standby, Turn down in the test mode.

**Enter:** Click to select or determine.

#### 2.2.1. Bottom Door Test

- > Press "TEST" to enter the bottom door test, as the picture shown in the right.
- > Press "Enter" key, the screen <OFF> turns <ON>, the bottom door begins to open and close continuously, Press "Enter" again, the bottom door stops.
- > When the bottom door is open, "OPEN" shows "ON" to indicate that the "open check" micro switch is normal.
- > When the bottom door is closed, "CLOSE" shows "ON" to indicate that the "off check" micro switch is normal.



#### 2.2.2. Top Door Test

- > Press "TEST", and press "DOWN" to enter the top door test, as the picture shown in the right.
- > Press "Enter" key, the screen <OFF> turns <ON>, the top door begins to open and close continuously, Press "Enter" again, the top door stops. When testing again, the top door rotates in opposite direction.
- > When the top door is open, "OPEN" shows "ON" to indicate that the "open check" micro switch is normal.
- > When the top door is closed, "CLOSE" shows "ON" to indicate that the "off check" micro switch is normal.



### 2.2.3. Blower test

- > Press "TEST",and press“DOWN”to enter the blower test, as the picture shown in the right.
- > Press "Enter"button, the screen <OFF> turns <ON>, the blower starts to work, Press "Enter" again, the blower stops.
- > When there is no ball at the bottom, the screen "SEN1" does not show "ON"; When there is a ball at the bottom, the screen "SEN1"will shows "ON".



### 2.2.4. Screen test

- > Press "TEST",and press“DOWN”to enter the screen test, as the picture shown in the right.
- > Press "Enter" button,the screen will shows red and green lines moving from top to bottom alternately,
- > Check whether the pixels on the screen are abnormal.



### 2.2.5. RGB LED test

- > Press "TEST",and press“DOWN”to enter the RGB LED test, as the picture shown in the right.
- > Press the “Enter” button,The LEDs of the machine will be turned on in turn.
- > R: ON ---- light red
- > G: ON ----light green
- > B: ON ----light blue
- > M: ON ----Mouth light

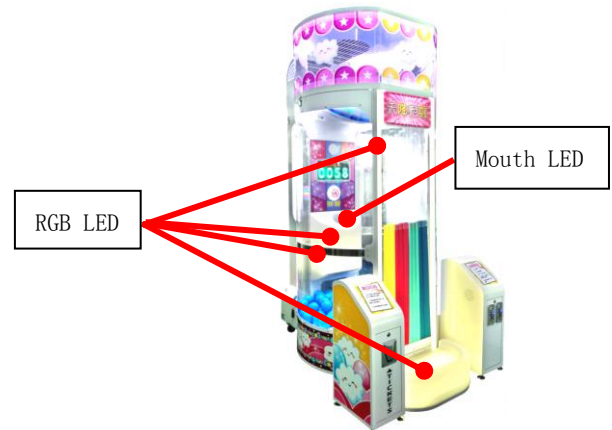

### 2.2.6. Coin Counter 1 Test

- > Press "TEST",and press “DOWN” to enter the Coin Counter 1 test, as the picture shown in the right.
- > Press the "Enter" key, the screen will shows "CCNT1:on" 0.5 second,And the coin counter 1 count 1.



### 2.2.7. Coin Counter 2 Test

- > Press "TEST",and press “DOWN” to enter the Coin Counter 1 test, as the picture shown in the right.
- > Press the "Enter" key, the screen will shows "CCNT2:on" 0.5 second,And the coin counter 2 count 1.





### 2.2.8. Ticket Counter Test

- > Press "TEST",and press “DOWN” to enter the Ticket Counter test, as the picture shown in the right.
- > Press the "Enter" key, the screen will shows "TCNT:on" 0.5 second,And the Ticket Counter count 1.



### 2.2.9. Ticket Out Test

- > Press "TEST",and press “DOWN” to enter the Ticket Out test, as the picture shown in the right.
- > Press the “ENTER” button and a ticket will be sent out at the ticket outlet.



### 2.2.10. Button LED Test

- > Press "TEST",and press “DOWN”to enter the Button LED test, as the picture shown in the right.
- > Press the “ENTER” button and the LED light in the <START> button will shine.



### 2.2.11. Sounds Test

- > Press "TEST",and press “DOWN” to enter the Sounds test, as the picture shown in the right.
- > Press the “ENTER” button, the screen shows the sound segment number and starts playing the segment sound.



### 2.2.12. Input signal Test

- > Press "TEST",and press “DOWN” to enter the Input signal test, as the picture shown in the right.
- > Each letter represents an input signal, by manually touching a signal's switch or sensor, to observe whether the corresponding letter on the screen changes, you can check whether the switch or sensor work is normal.



<b>A</b>	Coin selector1 Signal	<b>I</b>	Bottom door “CLOSE”sensor	<b>Q</b>	Enter button
<b>B</b>	Coin selector2 Signal	<b>J</b>	Ball pipe bottom sensor	<b>R</b>	*
<b>C</b>	Ticket Repair button	<b>K</b>	*	<b>S</b>	*
<b>D</b>	Ticket Machine Feedback Signal	<b>L</b>	Goal scoring A sensor	<b>T</b>	*
<b>E</b>	Start button	<b>M</b>	Goal Scoring B1 sensor	<b>U</b>	*
<b>F</b>	Top door “CLOSE”sensor (NH)	<b>N</b>	Goal Scoring B2 sensor	<b>V</b>	*
<b>G</b>	Top door “OPEN”sensor (NH)	<b>O</b>	Up(Test) button	<b>W</b>	*
<b>H</b>	Bottom door “OPEN”sensor	<b>P</b>	Down (Service) button	<b>X</b>	*

### 2.2.13. DIP Switch Test

- > Press "TEST",and press "DOWN" to enter the DIP Switch test, as the picture shown in the right.
- > Each letter represents an input signal, by manually touching a signal's switch or sensor, to observe whether the corresponding letter on the screen changes, you can check whether the switch work is normal.
- > Red means OFF,Green means ON
- > H represents the 1-8 bit of the SW1, the I-P represents 1-8 bit of SW2, and the Q-X represents 1-8 bit of SW3.



### 2.2.14. Time of Bottom door opened setting

- > Press "TEST",and press "DOWN" to enter the Time of Bottom door opened setting, as the picture shown in the right.
- > Press the "ENTER" button,the"<>" shows on the screen, and press the "Up" or "down" button to increase or decrease the value, and then press the "ENTER" button again to determine



### 2.2.15. Time of Bottom door closed setting

- > Press "TEST",and press "DOWN" to enter the Time of Bottom door closed setting, as the picture shown in the right.
- > Press the "ENTER" button,the"<>" shows on the screen, and press the "Up" or "down" button to increase or decrease the value, and then press the "ENTER" button again to determine.



### 2.2.16. Second drop time setting

- > Press "TEST",and press "DOWN" to enter the second drop time setting, as the picture shown in the right.
- > Press the "ENTER" button,the"<>" shows on the screen, and press the "Up" or "down" button to increase or decrease the value, and then press the "ENTER" button again to determine.



### 2.2.17. Restore factory setting

- > Press "TEST",and press "DOWN" to enter the Restore factory setting, as the picture shown in the right.
- > Press the "ENTER" button to Restore factory settings.



### 2.2.18. Software versions

- > Press "TEST",and press "DOWN" to enter the Software Version page, as the picture shown in the right.



### 2.2.19. Save and exit

- > Press "TEST",and press "DOWN" to enter the Save and exit page, as the picture shown in the right.
- > Press the "ENTER" button to save settings and Exit.



## 3. Fault & Resolution

### 3.1. Fault code description and fault handling

ERROR CODE	ERROR DESCRIPTION	FAULT ANALYSIS AND TREATMENT
Error 1	Program updated	The Program version has been changed. Reboot to remove the alarm.
Error 2	Data error	Save data error. 1、 restore the factory settings; 2、 Replace the motherboard.
Error 3	Coin selector 1 failure	1、 Check whether the Blocked coin in coin selector and take it out if there is. 2、 Check whether the SW1 switch of coin selector is in NC,if so,dial to NO. 3、 Replace the coin selector.
Error 4	Coin selector 2 failure	1、 Check whether the Blocked coin in coin selector and take it out if there is. 2、 Check whether the SW1 switch of coin selector is in NC,if so,dial to NO. 3、 Replace the coin selector.
TICKET IS EMPTY (Error 5)	Ticket is empty	The ticket is out, waiting to be added.The screen displays “SURP:xxx”to indicate the remaining tickets. 1、 Add ticket again,press the repair button next to the lottery machine,ticket can be output. 2、 If the device is not set to issue a ticket, the alarm can be set off by restoring the factory setting.
Error 6	Bottom door "Open" sensor error	1、 Check the bottom door for foreign matter sticking; 2、 Enter the bottom door test, heck the bottom door motor is working normally. If the motor doesn't turn, replace the motor; If there is no “Open” signal, adjust / lock or replace the sensor.
Error 7	Bottom door "Close" sensor error	1、 Check the bottom door for foreign matter sticking; 2、 Enter the bottom door test, heck the bottom door motor is working normally. If the motor doesn't turn, replace the motor; If there is no “Close” signal, adjust / lock or replace the sensor.
Error 8	Top door "open" sensor error	1、 Check the top door for foreign matter sticking; 2、 Check for loose belts and couplings; 3、 Enter the top door test, check the top door motor is working normally. If the motor doesn't turn, replace the motor; If there is no “open” signal, adjust the gap between the sensor and door or replace sensor.
Error 9	Top door "Close" sensor error	1、 Check the top door for foreign matter sticking; 2、 Check for loose belts and couplings; 3、 Enter the top door test, check the top door motor is working normally. If the motor doesn't turn, replace the motor; If there is no “Close” signal, adjust the gap between the sensor and door or replace sensor.

Error 10	Ball chute / ball pipe jam	<ol style="list-style-type: none"> <li>1、 Check if there is any foreign matter stuck in the ball pipe and remove it.</li> <li>2、 Empty the ball pipe ,enter the “browse all inputs” test,check whether there are green items in L、 M、 N, and change the corresponding sensor if there are.</li> <li>3、 Check if the position of sensors moved away if issue remains..</li> </ol>
----------	----------------------------	--

### 3. 2. Other fault analysis and treatment

1.The ball is stuck so frequently that the wind cannot blow it into the bin.

A-Check whether the weight of the ball exceeds 8g or not.

B-Check whether the voltage of the site is too low.

C-Check whether the fan inlet and outlet are blocked,if yes,clean up.

D-Check if the fan has accumulated and clean up if there is.

2.After each game,the blower has been working for a period of time.

A-Check if there is ball lingering in the end of the game ,if there is,reduce the ball or increase the game time.

B-Check the bottom door’s test sensor whether there is debris or dust.If there is,clean it up.

3.Lattice screen confused or irregular flashing

A-Check whether the wire is loose,if yes,plug the wire set.

B-Replace the display screen.

### 3. 3. Machine structure diagram

#### 3. 3. 1. Screen Component:

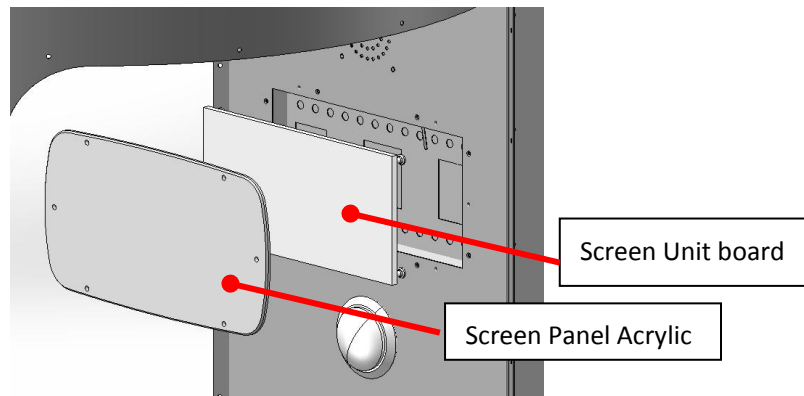

### 3. 3. 2. Top door components:

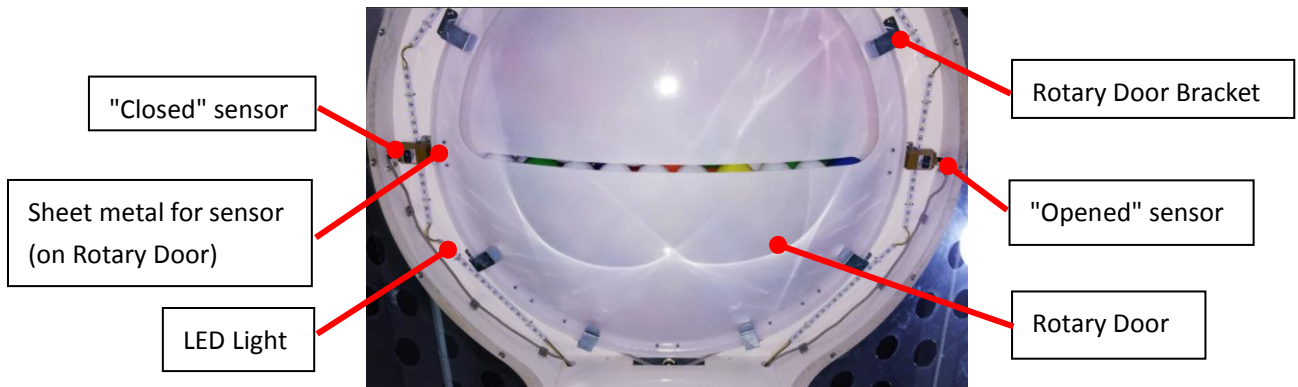
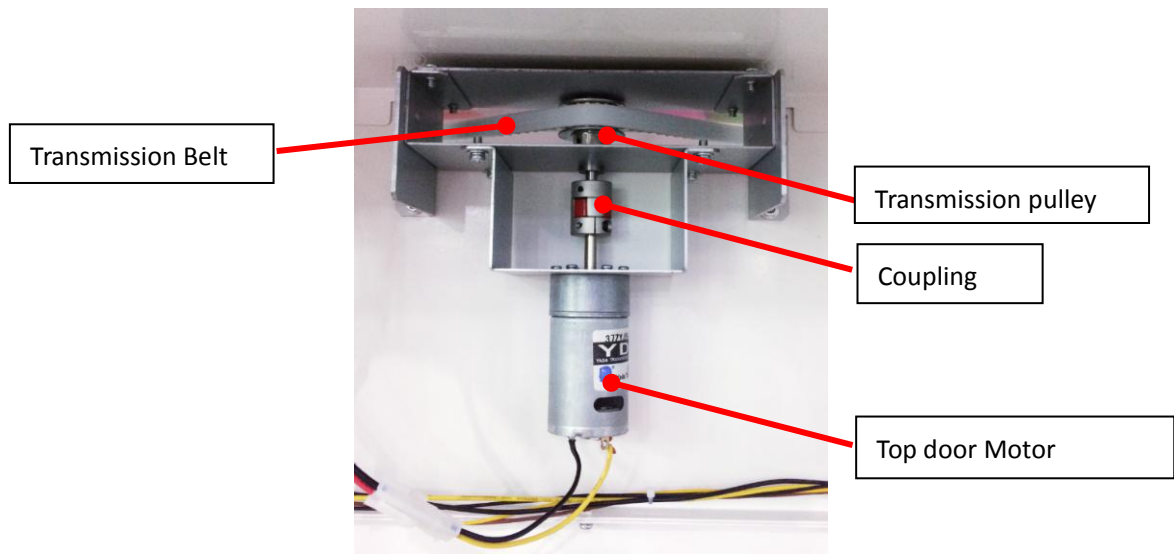

### 3. 3. 3. Bottom door Components:

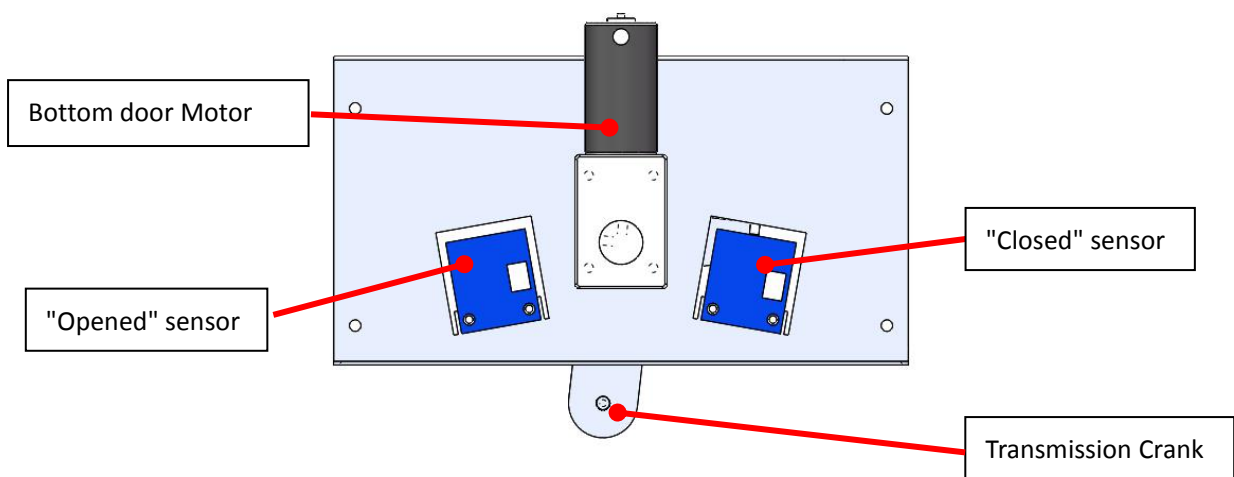

### 3.3.4. Power components:

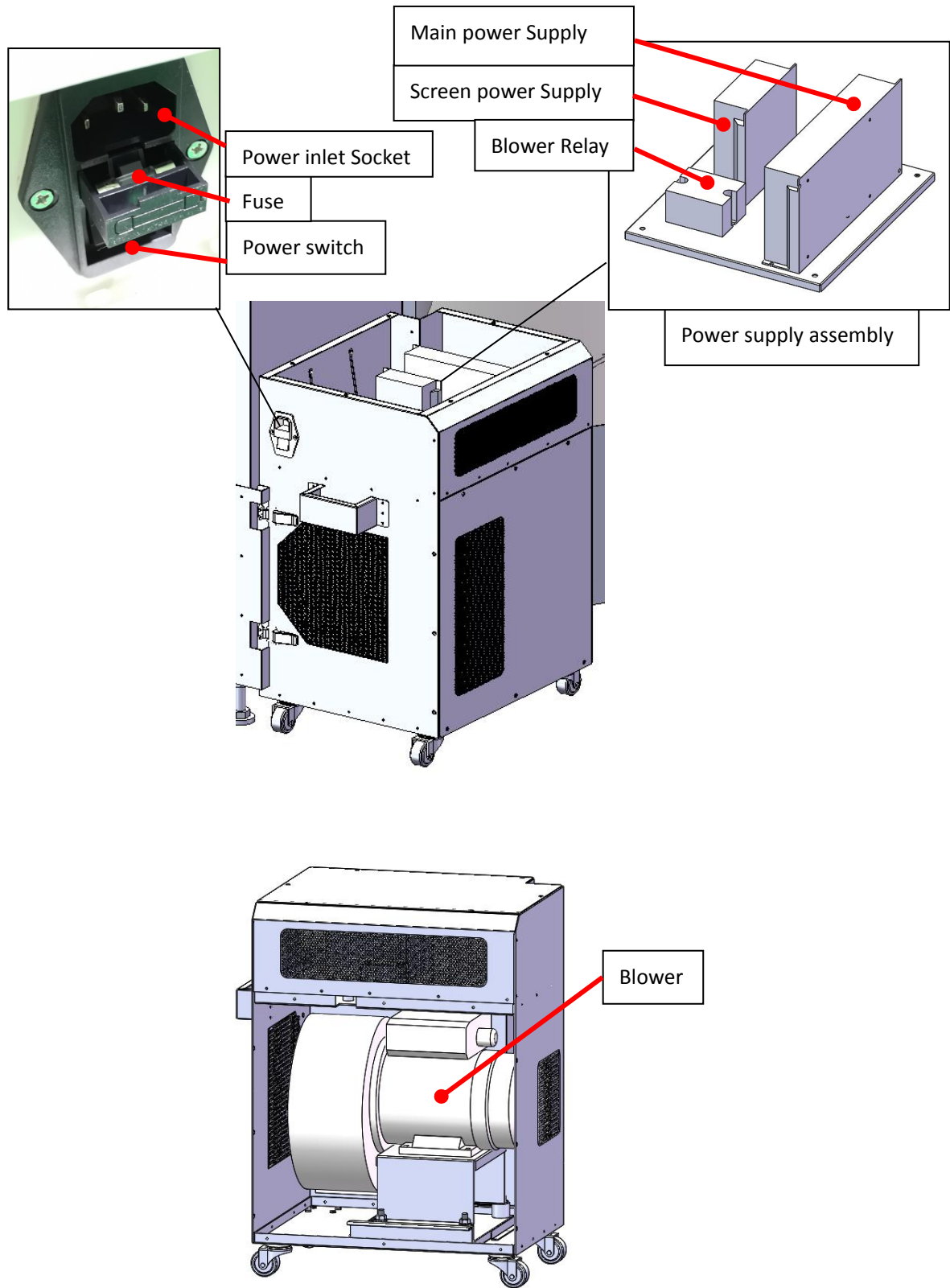

## 4. Machine maintenance

**Even if the machine works properly, in order to allow the machine to operate at its best, and for a longer period of time, check and maintain the following daily:**

- 1、 Check if the foot seat is normal to support the machine.
- 2、 Check whether the wind turbine is loose, whether the air inlet has debris accumulation
- 3、 Regular cleaning fan blade dust.
- 4、 Check whether the ball warehouse lock buckle loose.
- 5、 Check if the screws in the parts of the fixing are loose
- 6、 Check whether the connectors are loose and whether the terminals are off.

### **Maintenance Precautions:**

- 1、 For maintenance, please cut off the power supply to prevent the occurrence of workers or other people injured, electric shocks and so on.
- 2、 Do not mention the operation of this manual, please be sure to consult the company's after-sales service center, in accordance with the instructions, answer the operation.
- 3、 Consumables and Repair parts please use the company's designated products
- 4、 even if the main power supply, power panels and monitors inside or at high temperature and high pressure state, if encounter there will be burns, electric shock risk. Please be careful not to touch.

# 5. Wiring schematic

